



1



2



3



2



4

DENTAL 정밀가공에 최적화된 -

DENTAL SERIES

지르코니아 가공용 다이아몬드 코팅 볼 엔드밀

장비 제조사별 CAD/CAM Milling Bur

- 1 Cobalt-Chrome Disk
- 2 Zirconia 가공물
- 3 Abutment 가공물
- 4 Titanium Disk

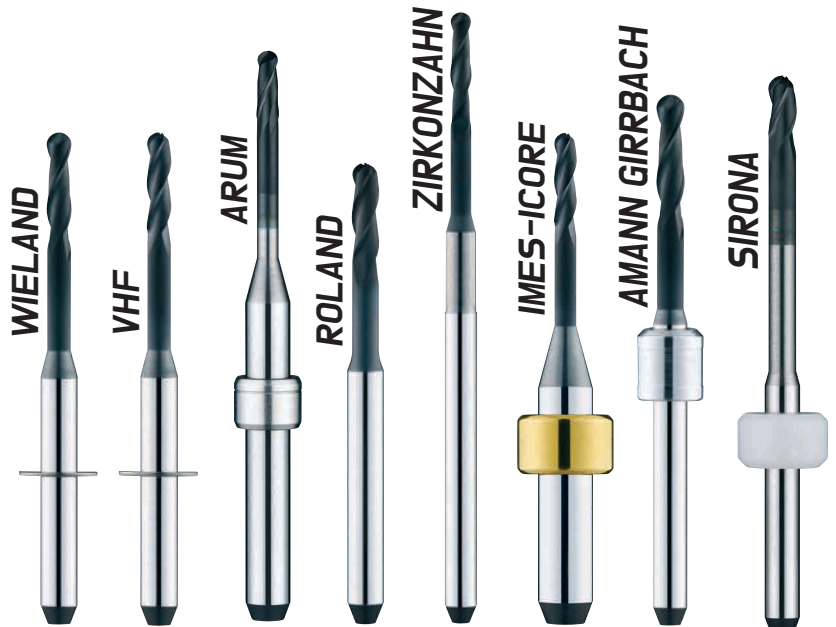

티타늄 / 코발트-크롬 / 어버트먼트 가공용 엔드밀
Rib Ball End Mills for Titanium & Cobalt-Chrom & Abutment

지르코니아 가공용 다이아몬드 코팅 엔드밀
Diamond Coated Ball End Mills for Zirconia

지르코니아 가공용 다이아몬드 코팅 엔드밀
Diamond Coated Ball End Mills for Zirconia

PMMA/PEEK/WAX 가공용 엔드밀
Rib Ball End Mills for PMMA & PEEK & WAK

전착 다이아몬드
Electro Deposited Diamond End Mill



Outstanding Abrasion Resistance & Surface Finishes!
탁월한 내마모성 및 경면조도!

DENTAL 정밀가공에 최적화된 -

DENTAL SERIES

2HRBD

2 Flutes High Speed Rib Ball End Mills for Titanium & Cobalt-Chrome

2날 티타늄 / 코발트-크롬 가공용 리브 볼 엔드밀

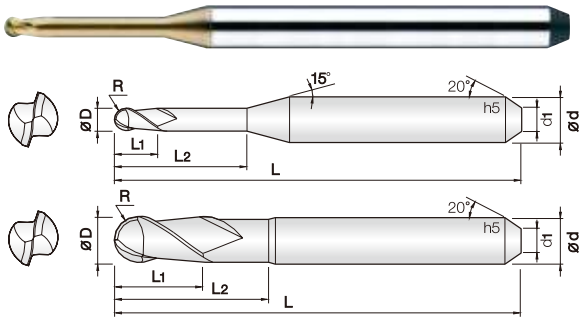

- 티타늄, 코발트-크롬 계열의 디스크 및 어버트먼트 정밀가공
- 실리콘계 코팅(Si) 처리하여 내마모성이 우수합니다.
- 고정밀 공차 적용으로 초정밀 가공에 적합합니다.
- Endmills for titanium and cobalt-chrom disk & abutment
- Good wear resistance by Si-based PVD coating.
- High precise edge tolerance.
- Very nice work surface finish.



0.3 ~ 1.5R Ø0.6-Ø3

단위 : mm

Order Number	날경 Diameter R × D	날장 Length of cut L1	유효장 Effective Length L2	전장 Overall Length L	생크소경 Shank Dia d1	생크 Shank Dia d	Order Number	날경 Diameter R × D	날장 Length of cut L1	유효장 Effective Length L2	전장 Overall Length L	생크소경 Shank Dia d1	생크 Shank Dia d
2HRBD 006 050 645	0.3R X 0.6	0.8	5	45	3.5	6	2HRBD 020 140 645	1R X 2	3	14	45	3.5	6
2HRBD 006 050 650	0.3R X 0.6	0.8	5	50	3.5	6	2HRBD 020 140 650	1R X 2	3	14	50	3.5	6
2HRBD 006 120 645	0.3R X 0.6	0.8	12	45	3.5	6	2HRBD 020 160 645	1R X 2	3	16	45	3.5	6
2HRBD 006 120 650	0.3R X 0.6	0.8	12	50	3.5	6	2HRBD 020 160 650	1R X 2	3	16	50	3.5	6
2HRBD 008 080 645	0.4R X 0.8	1	8	45	3.5	6	NEW 2HRBD 025 120 645	1.25R X 2.5	2.5	12	45	3.5	6
2HRBD 008 080 650	0.4R X 0.8	1	8	50	3.5	6	NEW 2HRBD 025 120 650	1.25R X 2.5	2.5	12	50	3.5	6
2HRBD 008 120 645	0.4R X 0.8	1	12	45	3.5	6	2HRBD 030 080 645	1.5R X 3	4	8	45	3.5	6
2HRBD 008 120 650	0.4R X 0.8	1	12	50	3.5	6	2HRBD 030 100 645	1.5R X 3	4	10	45	3.5	6
2HRBD 010 040 645	0.5R X 1	2	4	45	3.5	6	2HRBD 030 120 645	1.5R X 3	4	12	45	3.5	6
2HRBD 010 060 645	0.5R X 1	2	6	45	3.5	6	2HRBD 030 120 650	1.5R X 3	4	12	50	3.5	6
2HRBD 010 080 645	0.5R X 1	2	8	45	3.5	6	2HRBD 030 160 645	1.5R X 3	4	16	45	3.5	6
2HRBD 010 080 650	0.5R X 1	2	8	50	3.5	6	2HRBD 030 160 650	1.5R X 3	4	16	50	3.5	6
2HRBD 010 100 645	0.5R X 1	2	10	45	3.5	6							
2HRBD 010 100 650	0.5R X 1	2	10	50	3.5	6							
2HRBD 010 120 645	0.5R X 1	2	12	45	3.5	6							
2HRBD 010 120 650	0.5R X 1	2	12	50	3.5	6							
2HRBD 015 100 645	0.75R X 1.5	2.5	10	45	3.5	6							
NEW 2HRBD 015 100 650	0.75R X 1.5	2.5	10	50	3.5	6							
2HRBD 015 120 645	0.75R X 1.5	2.5	12	45	3.5	6							
2HRBD 015 120 650	0.75R X 1.5	2.5	12	50	3.5	6							
2HRBD 015 140 645	0.75R X 1.5	2.5	14	45	3.5	6							
2HRBD 015 140 650	0.75R X 1.5	2.5	14	50	3.5	6							
2HRBD 020 050 645	1R X 2	3	5	45	3.5	6							
2HRBD 020 080 645	1R X 2	3	8	45	3.5	6							
2HRBD 020 120 645	1R X 2	3	12	45	3.5	6							
2HRBD 020 120 650	1R X 2	3	12	50	3.5	6							

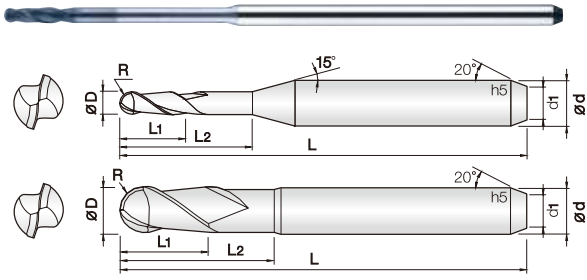

- 지르코니아(ZrO₂), 울티메이트(Ultimate) 등 비철,비금속 계열의 다양한 피삭재 전용 엔드밀
- NANO 다이아몬드 코팅(CVD)을 적용하여 가공물 표면 조도가 우수하며 공구의 내마모성이 탁월합니다.
- 공구의 규격을 다양화하여 단일치아 뿐만 아니라 브릿지 보철 가공시 폭넓은 가공이 가능합니다.
- **Endmills for Zirconia, Ultimate, Non-ferrous and non-metallic materials.**
- Excellent wear resistance and surface finishes by applying qualified CVD diamond coating
- Wide range products prepared for various work shape and excellent performance



0.25 ~ 1.5R Ø0.5 ~ Ø3

단위 : mm

Order Number	날경 Diameter R × D	날장 Length of cut L1	유효장 Effective Length L2	전장 Overall Length L	샹크소경 Shank Dia d1	샹크 Shank Dia d
2DBED 005 050 345	0.25R X 0.5	1.5	5	45	1.2	3
2DBED 005 050 350	0.25R X 0.5	1.5	5	50	1.2	3
2DBED 005 050 445	0.25R X 0.5	1.5	5	45	1.5	4
2DBED 005 050 450	0.25R X 0.5	1.5	5	50	1.5	4
2DBED 005 050 645	0.25R X 0.5	1.5	5	45	3.5	6
2DBED 005 050 650	0.25R X 0.5	1.5	5	50	3.5	6
2DBED 005 120 345	0.25R X 0.5	1.5	12	45	1.2	3
2DBED 005 120 350	0.25R X 0.5	1.5	12	50	1.2	3
2DBED 005 120 445	0.25R X 0.5	1.5	12	45	1.5	4
2DBED 005 120 450	0.25R X 0.5	1.5	12	50	1.5	4
2DBED 005 120 645	0.25R X 0.5	1.5	12	45	3.5	6
2DBED 005 120 650	0.25R X 0.5	1.5	12	50	3.5	6
2DBED 006 050 345	0.3R X 0.6	2	5	45	1.2	3
2DBED 006 050 350	0.3R X 0.6	2	5	50	1.2	3
2DBED 006 050 445	0.3R X 0.6	2	5	45	1.5	4
2DBED 006 050 450	0.3R X 0.6	2	5	50	1.5	4
2DBED 006 050 645	0.3R X 0.6	2	5	45	3.5	6
2DBED 006 050 650	0.3R X 0.6	2	5	50	3.5	6
2DBED 006 120 345	0.3R X 0.6	2	12	45	1.2	3
2DBED 006 120 350	0.3R X 0.6	2	12	50	1.2	3
2DBED 006 120 445	0.3R X 0.6	2	12	45	1.5	4
2DBED 006 120 450	0.3R X 0.6	2	12	50	1.5	4
2DBED 006 120 645	0.3R X 0.6	2	12	45	3.5	6
2DBED 006 120 650	0.3R X 0.6	2	12	50	3.5	6
2DBED 010 160 350	0.5R X 1	6	16	50	1.2	3
2DBED 010 160 355	0.5R X 1	6	16	55	1.2	3
2DBED 010 160 450	0.5R X 1	6	16	50	1.5	4
2DBED 010 160 455	0.5R X 1	6	16	55	1.5	4
2DBED 010 160 650	0.5R X 1	6	16	50	3.5	6
2DBED 010 160 655	0.5R X 1	6	16	55	3.5	6
2DBED 010 180 350	0.5R X 1	6	18	50	1.2	3
2DBED 010 180 355	0.5R X 1	6	18	55	1.2	3
2DBED 010 180 450	0.5R X 1	6	18	50	1.5	4
2DBED 010 180 455	0.5R X 1	6	18	55	1.5	4
2DBED 010 180 650	0.5R X 1	6	18	50	3.5	6
2DBED 010 180 655	0.5R X 1	6	18	55	3.5	6
2DBED 020 160 350	1R X 2	8	16	50	1.2	3
2DBED 020 160 355	1R X 2	8	16	55	1.2	3
2DBED 020 160 450	1R X 2	8	16	50	1.5	4
2DBED 020 160 455	1R X 2	8	16	55	1.5	4
2DBED 020 160 650	1R X 2	8	16	50	3.5	6
2DBED 020 160 655	1R X 2	8	16	55	3.5	6
2DBED 020 200 350	1R X 2	8	20	50	1.2	3
2DBED 020 200 355	1R X 2	8	20	55	1.2	3
2DBED 020 200 450	1R X 2	8	20	50	1.5	4
2DBED 020 200 455	1R X 2	8	20	55	1.5	4
2DBED 020 200 650	1R X 2	8	20	50	3.5	6
2DBED 020 200 655	1R X 2	8	20	55	3.5	6
2DBED 030 200 355	1.5R X 3	10	20	55	1.2	3
2DBED 030 200 455	1.5R X 3	10	20	55	1.5	4
2DBED 030 200 655	1.5R X 3	10	20	55	3.5	6

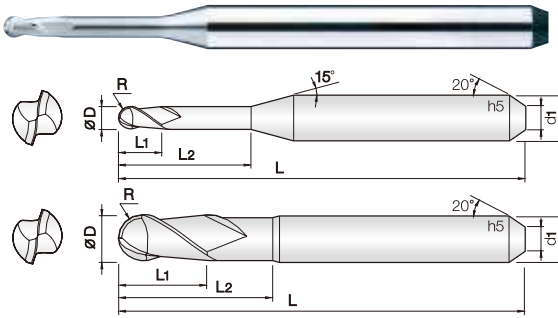

- 플라스틱(PMMK), PEEK, WAX, ABS 등 비철 비금속 가공
- 균일한 런아웃 공차관리로 떨림을 최소화 하였습니다.
- 고속, 고이송 작업시 짧은 날장을 채택하여 공구의 강성이 우수합니다.
- 인선부 강성을 보강하여 날부치핑을 최소화 하였습니다.
- 미립자 초경합금을 채태하여 내마모성이 좋습니다.
- Endmills for PMMA, PEEK, WAX, A.B.S, non-ferrous and non-metallic materials.
- Minimize chattering by even run-out and tolerance control.
- Excellent tool rigidity by short flute design at high speed, feed machining
- Reinforced edge design for preventing edge chipping.
- Excellent wear resistance by applying fine WC grade.



단위 : mm

Order Number		날경 Diameter R × D	날장 Length of cut L1	유효장 Effective Length L2	전장 Overall Length L	샙크소경 Shank Dia d1	샙크 Shank Dia d
비코팅 Non coated	코팅 Coated						
NEW 2MRBD 003 140 450	2MRBDD 003 140 450	0.15R X 0.3	1	14 (2.5°)	50	1.5	4
2MRBD 006 050 450	2MRBDD 006 050 450	0.3R X 0.6	2	5	50	1.5	4
2MRBD 006 050 650	2MRBDD 006 050 650	0.3R X 0.6	2	5	50	3.5	6
2MRBD 006 100 450	2MRBDD 006 100 450	0.3R X 0.6	2	10	50	1.5	4
2MRBD 006 100 650	2MRBDD 006 100 650	0.3R X 0.6	2	10	50	3.5	6
2MRBD 010 140 455	2MRBDD 010 140 455	0.5R X 1	6	14	55	1.5	4
2MRBD 010 140 655	2MRBDD 010 140 655	0.5R X 1	6	14	55	3.5	6
NEW 2MRBD 010 160 450	2MRBDD 010 160 450	0.5R X 1	6	16	55	1.5	4
2MRBD 010 160 455	2MRBDD 010 160 455	0.5R X 1	6	16	50	1.5	4
2MRBD 010 160 655	2MRBDD 010 160 655	0.5R X 1	6	16	55	3.5	6
2MRBD 020 160 455	2MRBDD 020 160 455	1R X 2	8	16	55	1.5	4
2MRBD 020 160 655	2MRBDD 020 160 655	1R X 2	8	16	55	3.5	6
NEW 2MRBD 020 180 450	2MRBDD 020 180 450	1R X 2	8	18	50	1.5	4
NEW 2MRBD 020 180 650	2MRBDD 020 180 650	1R X 2	8	18	50	3.5	6
2MRBD 020 200 455	2MRBDD 020 200 455	1R X 2	8	20	55	1.5	4
2MRBD 020 200 655	2MRBDD 020 200 655	1R X 2	8	20	55	3.5	6



Carbide Electro Deposited Diamond End Mill

초경 전착 다이아몬드 엔드밀

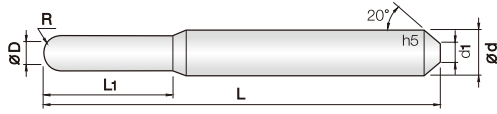

- 지르코니아(ZrO₂), E-MAX, 얼티메이트(Ultimate) 등 비철 비금속 가공 엔드밀
- 완전 소결된 지르코니아, 세라믹, 글라스 등의 가공에 적합합니다.
- 다이아몬드 입자를 니켈 도금하여 내마모 성능이 탁월합니다.
- 초경 모재를 사용하여 공구 휨이 적어 정밀가공에 적합합니다.
- Endmills for Zirconia, E-MAX, Ultimate, Non-ferrous and non-matallic materials.
- Milling process is suitable for completely sintered zirconia, ceramic and glass.
- Wear resistace is excellnt by applying diamond particle with nickal plating.
- Precision processing is available with less bending on the tool with carbide material.

단위 : mm

Order Number	날경 Diameter R × D	날장 Length of cut L1	전장 Overall Length L	생크소경 Shank Dia d1	생크 Shank Dia d
EDD 006 060 340	0.3R X 0.6	6	40	1.6	3
EDD 006 060 350	0.3R X 0.6	6	50	1.6	3
EDD 006 060 440	0.3R X 0.6	6	40	2	4
EDD 006 060 450	0.3R X 0.6	6	50	2	4
EDD 006 060 640	0.3R X 0.6	6	40	4.2	6
EDD 006 060 650	0.3R X 0.6	6	50	4.2	6
EDD 010 100 340	0.5R X 1	10	40	1.6	3
EDD 010 100 350	0.5R X 1	10	50	1.6	3
EDD 010 100 440	0.5R X 1	10	40	2	4
EDD 010 100 450	0.5R X 1	10	50	2	4
EDD 010 100 640	0.5R X 1	10	40	4.2	6
EDD 010 100 650	0.5R X 1	10	50	4.2	6
EDD 015 080 450	0.75R X 1.5	8	50	2	4
NEW EDD 015 120 450	0.75R X 1.5	12	50	2	4

Order Number	날경 Diameter R × D	날장 Length of cut L1	전장 Overall Length L	생크소경 Shank Dia d1	생크 Shank Dia d
NEW EDD 015 120 650	0.75R X 1.5	12	50	4.2	6
NEW EDD 015 150 650	0.75R X 1.5	15	50	4.2	6
EDD 020 120 340	1R X 2	12	40	1.6	3
EDD 020 120 350	1R X 2	12	50	1.6	3
EDD 020 120 440	1R X 2	12	40	2	4
EDD 020 120 450	1R X 2	12	50	2	4
EDD 020 120 640	1R X 2	12	40	4.2	6
EDD 020 120 650	1R X 2	12	50	4.2	6
EDD 025 150 340	1.25R X 2.5	15	40	1.6	3
EDD 025 150 350	1.25R X 2.5	15	50	1.6	3
EDD 025 150 440	1.25R X 2.5	15	40	2	4
EDD 025 150 450	1.25R X 2.5	15	50	2	4
EDD 025 150 640	1.25R X 2.5	15	40	4.2	6
EDD 025 150 650	1.25R X 2.5	15	50	4.2	6



Steel Electro Deposited Diamond End Mill

스틸 전착 다이아몬드 엔드밀

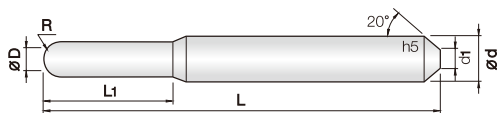

- 지르코니아(ZrO₂), E-MAX, 얼티메이트(Ultimate) 등 비철 비금속 가공 엔드밀
- 완전 소결된 지르코니아, 세라믹, 글라스 등의 가공에 적합합니다.
- 다이아몬드 입자를 니켈 도금하여 내마모 성능이 탁월합니다.
- 다이아몬드 입자와 모재의 밀착력이 좋아, 피삭재 가공력이 뛰어납니다.
- Endmills for Zirconia, E-MAX, Ultimate, Non-ferrous and non-matallic materials.
- Milling process is suitable for completely sintered zirconia, ceramic and glass.
- Wear resistace is excellnt by applying diamond particle with nickal plating.
- High adhesion of diamond particles and carbide material, milling Pocess is excellnt on a workpiece.

단위 : mm

Order Number	날경 Diameter R × D	날장 Length of cut L1	전장 Overall Length L	생크소경 Shank Dia d1	생크 Shank Dia d
EDDH 006 060 340	0.3R X 0.6	6	40	1.6	3
EDDH 006 060 350	0.3R X 0.6	6	50	1.6	3
EDDH 006 060 440	0.3R X 0.6	6	40	2	4
EDDH 006 060 450	0.3R X 0.6	6	50	2	4
EDDH 006 060 640	0.3R X 0.6	6	40	4.2	6
EDDH 006 060 650	0.3R X 0.6	6	50	4.2	6
EDDH 010 100 340	0.5R X 1	10	40	1.6	3
EDDH 010 100 350	0.5R X 1	10	50	1.6	3
EDDH 010 100 440	0.5R X 1	10	40	2	4
EDDH 010 100 450	0.5R X 1	10	50	2	4
EDDH 010 100 640	0.5R X 1	10	40	4.2	6
EDDH 010 100 650	0.5R X 1	10	50	4.2	6
EDDH 015 080 450	0.75R X 1.5	8	50	2	4
EDDH 015 120 450	0.75R X 1.5	12	50	2	4

Order Number	날경 Diameter R × D	날장 Length of cut L1	전장 Overall Length L	생크소경 Shank Dia d1	생크 Shank Dia d
EDDH 015 120 650	0.75R X 1.5	12	50	4.2	6
EDDH 015 150 650	0.75R X 1.5	15	50	4.2	6
EDDH 020 120 340	1R X 2	12	40	1.6	3
EDDH 020 120 350	1R X 2	12	50	1.6	3
EDDH 020 120 440	1R X 2	12	40	2	4
EDDH 020 120 450	1R X 2	12	50	2	4
EDDH 020 120 640	1R X 2	12	40	4.2	6
EDDH 020 120 650	1R X 2	12	50	4.2	6
EDDH 025 150 340	1.25R X 2.5	15	40	1.6	3
EDDH 025 150 350	1.25R X 2.5	15	50	1.6	3
EDDH 025 150 440	1.25R X 2.5	15	40	2	4
EDDH 025 150 450	1.25R X 2.5	15	50	2	4
EDDH 025 150 640	1.25R X 2.5	15	40	4.2	6
EDDH 025 150 650	1.25R X 2.5	15	50	4.2	6

1VHF 1날 PMMA/PEEK/WAX 가공용 리브 볼 엔드밀

1 Flutes Rib Ball End Mills for PMMA & PEEK & WAX

호환 장비 (Competible Machine)
4AXES, Wieland, Brux Zir, EzMill, Jensen

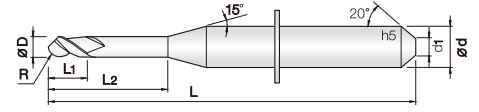

1
WC 미립자
PMMA
PEEK
WAX
R ±0.01
D +0-0.01
30° Helix Angle

0.3 ~ 1R Ø0.6 ~ Ø2

- 플라스틱 (PMMA), PEEK, WAX, ABS 등 비철, 비금속 가공
- Endmills for PMMA, PEEK, WAX, A.B.S, non-ferrous and non-metallic materials.

단위: mm

Order Number	날경 Diameter R × D	날장 Length of cut L1	유효장 Effective Length L2	전장 Overall Length L	생크소경 Shank Dia d1	생크 Shank Dia d
1VHF 006 070 S03	0.3R X 0.6	2	7	35	1.6	3
1VHF 006 110 S03	0.3R X 0.6	2	11	35	1.6	3
1VHF 010 160 S03	0.5R X 1	5	16	35	1.6	3
1VHF 020 170 S03	1R X 2	8	17	35	1.6	3

2&3VHF 2&3날 지르코니아 가공용 리브 볼 엔드밀

2 & 3 Flutes Rib Ball End Mills for Zirconia

호환 장비 (Competible Machine)
4AXES, Wieland, Brux Zir, EzMill, Jensen

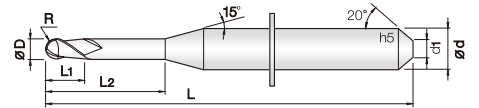

2
3
WC 미립자
ZrO₂
R ±0.01
D +0-0.01
30° Helix Angle

0.3 ~ 1R Ø0.6 ~ Ø2

- 지르코니아 (ZrO₂), 얼티메이트 (ULTIMATE) 등 비철 비금속 가공
- Endmills for Zirconia, Ultimate, non-ferrous and non-metallic materials.

단위: mm

Order Number	날경 Diameter R × D	날장 Length of cut L1	유효장 Effective Length L2	전장 Overall Length L	생크소경 Shank Dia d1	생크 Shank Dia d
2VHF 006 070 S03	0.3R X 0.6	2	7	35	1.6	3
2VHF 006 110 S03	0.3R X 0.6	2	11	35	1.6	3
2VHF 010 160 S03	3VHF 010 160 S03 0.5R X 1	5	16	35	1.6	3
2VHF 020 170 S03	3VHF 020 170 S03 1R X 2	8	17	35	1.6	3

2&3VHFD 2&3날 지르코니아 가공용 다이아몬드 코팅 리브 볼 엔드밀

2 & 3 Flutes Diamond Coated Ball End Mills for Zirconia

호환 장비 (Competible Machine)
5AXES, Wieland, Brux Zir, EzMill, Jensen

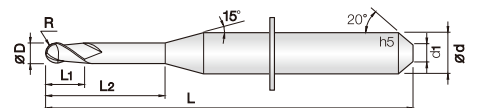

2
3
WC 미립자
ZrO₂
NANO DIA. Coating
R ±0.01
D +0-0.01
30° Helix Angle

0.3 ~ 1R Ø0.6 ~ Ø3

- 지르코니아 (ZrO₂), 얼티메이트 (ULTIMATE) 등 비철 비금속 가공
- Endmills for Zirconia, Ultimate, non-ferrous and non-metallic materials.

단위: mm

Order Number	날경 Diameter R × D	날장 Length of cut L1	유효장 Effective Length L2	전장 Overall Length L	생크소경 Shank Dia d1	생크 Shank Dia d
2VHFD 006 070 S03	0.3R X 0.6	2	7	40	1.6	3
2VHFD 006 110 S03	0.3R X 0.6	2	11	40	1.6	3
2VHFD 010 170 S03	3VHFD 010 170 S03 0.5R X 1	5	17	40	1.6	3
2VHFD 020 170 S03	3VHFD 020 170 S03 1R X 2	8	17	40	1.6	3

1WIE 1날 PMM/PEEK/WAX 가공용 리브 볼 엔드밀

1 Flutes Rib Ball End Mills for PMMA & PEEK & WAX

호환 장비 (Compatible Machine)
Wieland mini, Select

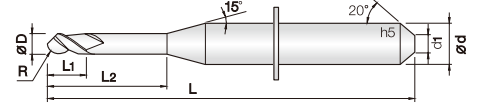

- 플라스틱 (PMMA), PEEK, WAX, ABS 등 비철, 비금속 가공
- Endmills for PMMA, PEEK, WAX, A.B.S, non-ferrous and non-metallic materials.

단위 : mm

Order Number	날경 Diameter R × D	날장 Length of cut L1	유효장 Effective Length L2	전장 Overall Length L	생크소경 Shank Dia d1	생크 Shank Dia d
1WIE 006 070 335	0.3R X 0.6	2	7	35	1.6	3
1WIE 006 070 340	0.3R X 0.6	2	7	40	1.6	3
1WIE 007 070 335	0.35R X 0.7	2	7	35	1.6	3
1WIE 007 070 340	0.35R X 0.7	2	7	40	1.6	3
1WIE 010 160 335	0.5R X 1	5	16	35	1.6	3
1WIE 010 170 340	0.5R X 1	5	17	40	1.6	3
1WIE 020 170 335	1R X 2	8	17	35	1.6	3
1WIE 020 170 340	1R X 2	8	17	40	1.6	3
1WIE 025 200 335	1.25R X 2.5	10	20	35	1.6	3
1WIE 025 200 340	1.25R X 2.5	10	20	40	1.6	3

2&3WIE 2&3날 지르코니아 가공용 리브 볼 엔드밀

2 & 3 Flutes Rib Ball End Mills for Zirconia

호환 장비 (Compatible Machine)
Wieland mini

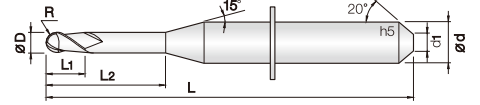

- 지르코니아 (ZrO2), 얼티메이트 (ULTIMATE) 등 비철 비금속 가공
- Endmills for Zirconia, Ultimate, non-ferrous and non-metallic materials.

단위 : mm

Order Number	날경 Diameter R × D	날장 Length of cut L1	유효장 Effective Length L2	전장 Overall Length L	생크소경 Shank Dia d1	생크 Shank Dia d
2WIE 006 070 335	0.3R X 0.6	2	7	35	1.6	3
2WIE 007 070 335	0.35R X 0.7	2	7	35	1.6	3
2WIE 010 160 335	3WIE 010 160 335	0.5R X 1	5	16	1.6	3
2WIE 020 170 335	3WIE 020 170 335	1R X 2	8	17	1.6	3
2WIE 025 200 335	3WIE 025 200 335	1.25R X 2.5	10	20	1.6	3

2&3WIED 2&3날 지르코니아 가공용 다이아몬드 코팅 볼 엔드밀

2 & 3 Flutes Diamond Coated Ball End Mills for Zirconia

호환 장비 (Compatible Machine)
Wieland Select

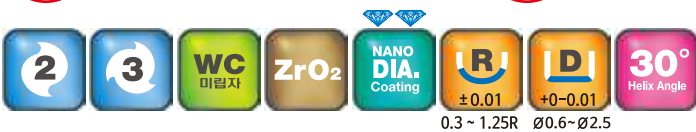
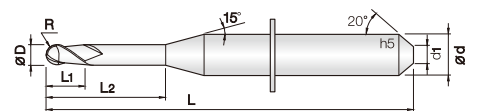

- 지르코니아 (ZrO2), 얼티메이트 (ULTIMATE) 등 비철 비금속 가공
- Endmills for Zirconia, Ultimate, non-ferrous and non-metallic materials.

단위 : mm

Order Number	날경 Diameter R × D	날장 Length of cut L1	유효장 Effective Length L2	전장 Overall Length L	생크소경 Shank Dia d1	생크 Shank Dia d
2WIED 006 070 340	0.3R X 0.6	2	7	40	1.6	3
2WIED 007 070 340	0.35R X 0.7	2	7	40	1.6	3
2WIED 010 170 340	3WIED 010 170 340	0.5R X 1	5	17	1.6	3
2WIED 020 170 340	3WIED 020 170 340	1R X 2	8	17	1.6	3
2WIED 025 200 340	3WIED 025 200 340	1.25R X 2.5	10	20	1.6	3



1날 PMMA/PEEK/WAX 가공용 리브 볼 엔드밀 1 Flutes Rib Ball End Mills for PMMA & PEEK & WAX

호환 장비 (Competible Machine)
250i, 450i, 540i, DMG

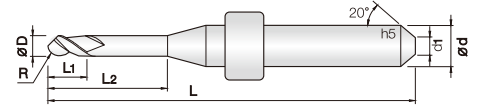

1
WC 미립자
PMMA
PEEK
WAX
R ±0.01
D +0-0.01
30° Helix Angle

0.3 ~ 1.25R Ø0.6 ~ Ø2.5

- 플라스틱 (PMMA), PEEK, WAX, ABS 등 비철, 비금속 가공
- Endmills for PMMA, PEEK, WAX, A.B.S, non-ferrous and non-metallic materials.

단위 : mm

Order Number	날경 Diameter R × D	날장 Length of cut L1	유효장 Effective Length L2	전장 Overall Length L	샙크소경 Shank Dia d1	샙크 Shank Dia d
1IME 006 070 S03	0.3R X 0.6	2	7	48	1.6	3
1IME 006 070 S06	0.3R X 0.6	2	7	53	4.2	6
1IME 0065 120 S03	0.325R X 0.65	2	12	48	1.6	3
1IME 0065 120 S06	0.325R X 0.65	2	12	53	4.2	6
1IME 010 160 S03	0.5R X 1	2	16	48	1.6	3
1IME 010 160 S06	0.5R X 1	2	16	53	4.2	6
1IME 020 200 S03	1R X 2	8	20	48	1.6	3
1IME 020 200 S06	1R X 2	8	20	53	4.2	6
1IME 025 200 S03	1.25R X 2.5	9	20	48	1.6	3
1IME 025 200 S06	1.25R X 2.5	9	20	53	4.2	6



2&3날 지르코니아 가공용 다이아몬드 코팅 볼 엔드밀 2&3 Flutes Diamond Coated Ball End Mills for Zirconia

호환 장비 (Competible Machine)
250i

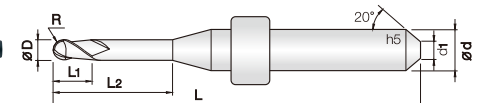

2
3
WC 미립자
ZrO₂
NANO DIA. Coating
R ±0.01
D +0-0.01
30° Helix Angle

0.3 ~ 1.25R Ø0.6 ~ Ø2.5

- 지르코니아 (ZrO₂), 얼티메이트 (ULTIMATE) 등 비철 비금속 가공
- Endmills for Zirconia, Ultimate, non-ferrous and non-metallic materials.

단위 : mm

Order Number	날경 Diameter R × D	날장 Length of cut L1	유효장 Effective Length L2	전장 Overall Length L	샙크소경 Shank Dia d1	샙크 Shank Dia d
2IME 006 070 S03	0.3R X 0.6	2	7	48	1.6	3
2IME 0065 120 S03	0.325R X 0.65	2	12	48	1.6	3
2IME 010 160 S03	3IME 010 160 S03	0.5R X 1	2	16	1.6	3
2IME 020 200 S03	3IME 020 200 S03	1R X 2	8	20	1.6	3
2IME 025 200 S03	3IME 025 200 S03	1.25R X 2.5	9	20	1.6	3



2&3날 지르코니아 가공용 다이아몬드 코팅 볼 엔드밀 2&3 Flutes Diamond Coated Ball End Mills for Zirconia

호환 장비 (Competible Machine)
450i, 540i, DMG

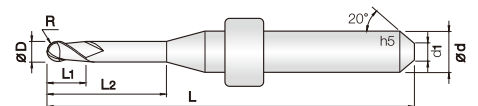

2
3
WC 미립자
ZrO₂
NANO DIA. Coating
R ±0.01
D +0-0.01
30° Helix Angle

0.3 ~ 1.25R Ø0.6 ~ Ø2.5

- 지르코니아 (ZrO₂), 얼티메이트 (ULTIMATE) 등 비철 비금속 가공
- Endmills for Zirconia, Ultimate, non-ferrous and non-metallic materials.

단위 : mm

Order Number	날경 Diameter R × D	날장 Length of cut L1	유효장 Effective Length L2	전장 Overall Length L	샙크소경 Shank Dia d1	샙크 Shank Dia d
2IME 006 070 S06	0.3R X 0.6	2	7	53	4.2	6
2IME 0065 120 S06	0.325R X 0.65	2	12	53	4.2	6
2IME 010 160 S06	3IME 010 160 S06	0.5R X 1	2	16	4.2	6
2IME 020 200 S06	3IME 020 200 S06	1R X 2	8	53	4.2	6
2IME 025 200 S06	3IME 025 200 S06	1.25R X 2.5	9	20	4.2	6

2SIR 1날 PMMA/PEEK/WAX 가공용 리브 볼 엔드밀 1 Flutes Rib Ball End Mills for PMMA & PEEK & WAX

호환 장비 (Competible Machine)
Inlab MC X5

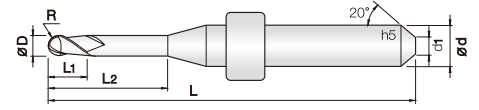

2 WC 미립자 PMMA PEEK WAX UR ±0.01 DI +0-0.01 30° Helix Angle
 0.25 ~ 1.25R Ø0.5~Ø2.5

- 플라스틱 (PMMA), PEEK, WAX, ABS 등 비철, 비금속 가공
- Endmills for PMMA, PEEK, WAX, A.B.S, non-ferrous and non-metallic materials.

단위 : mm

Order Number	날경 Diameter R × D	날장 Length of cut L1	유효장 Effective Length L2	전장 Overall Length L	생크소경 Shank Dia d1	생크 Shank Dia d
2SIR 005 060 342	0.25R X 0.5	0.8	6	42	2	3
2SIR 010 170 343	0.5R X 1	2.7	17	43	2	3
2SIR 025 250 344	1.25R X 2.5	5	25	44	2	3

2&3SIRD 2&3날 지르코니아 가공용 다이아몬드 코팅 볼 엔드밀 2&3 Flutes Diamond Coated Ball End Mills for Zirconia

호환 장비 (Competible Machine)
Inlab MC X5

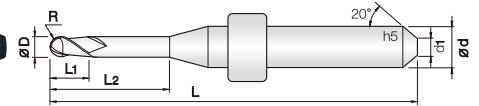
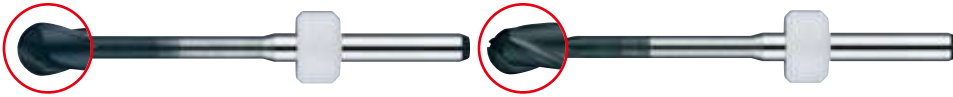

2 3 WC 미립자 ZrO₂ NANO DIA. Coating UR ±0.01 DI +0-0.01 30° Helix Angle
 0.25 ~ 1.25R Ø0.5~Ø2.5

- 지르코니아 (ZrO₂), 얼티메이트 (ULTIMATE) 등 비철 비금속 가공
- Endmills for Zirconia, Ultimate, non-ferrous and non-metallic materials.

단위 : mm

Order Number	날경 Diameter R × D	날장 Length of cut L1	유효장 Effective Length L2	전장 Overall Length L	생크소경 Shank Dia d1	생크 Shank Dia d
2SIRD 005 050 342	0.25R X 0.5	1	5	42	2	3
2SIRD 010 180 343	0.5R X 1	3	18	43	2	3
2SIRD 025 250 344	1.25R X 2.5	5	25	44	2	3

2SIRT 2날 티타늄 / 코발트-크롬 가공용 리브 볼 엔드밀 2 Flutes Rib Ball End Mills for Titanium & Cobalt-Chrome

호환 장비 (Competible Machine)
Inlab MC X5

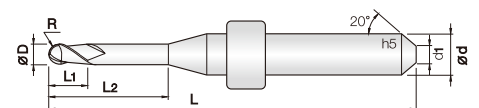
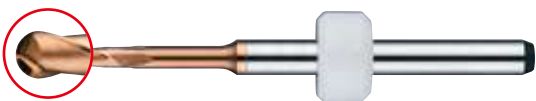

2 WC 미립자 TITAN TISIN Coating UR ±0.01 DI +0-0.01 30° Helix Angle
 0.5 ~ 1.5R Ø1~Ø3

- 티타늄, 코발트-크롬 계열의 디스크 및 어버트먼트 정밀가공
- Endmills for titanium and cobalt-chrome disk & abutment

단위 : mm

Order Number	날경 Diameter R × D	날장 Length of cut L1	유효장 Effective Length L2	전장 Overall Length L	생크소경 Shank Dia d1	생크 Shank Dia d
2SIRT 010 080 338	0.5R X 1	3.3	8	38	2	3
2SIRT 020 120 349	1R X 2	4.5	12	39	2	3

1ARU 1날 PMMA/PEEK/WAX 가공용 리브 볼 엔드밀

1 Flutes Rib Ball End Mills for PMMA & PEEK & WAX

호환 장비 (Competible Machine)
5X100, 5X150

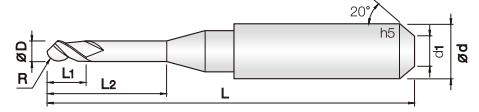

- 플라스틱 (PMMA), PEEK, WAX, ABS 등 비철, 비금속 가공
- Endmills for PMMA, PEEK, WAX, A.B.S, non-ferrous and non-metallic materials.

단위 : mm

Order Number	날경 Diameter R x D	날장 Length of cut L1	유효장 Effective Length L2	전장 Overall Length L	생크소경 Shank Dia d1	생크 Shank Dia d
1ARU 006 130 063	0.3R X 0.6	2	13	63	4.2	6
1ARU 010 160 063	0.5R X 1	6	16	63	4.2	6
1ARU 020 200 063	1R X 2	8	20	63	4.2	6

2ARU 2날 PMMA/PEEK/WAX 가공용 리브 볼 엔드밀 New

2 Flutes Rib Ball End Mills for PMMA & PEEK & WAX

호환 장비 (Competible Machine)
5X300

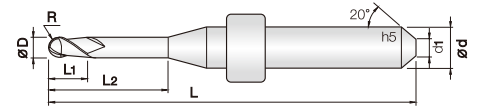

- 플라스틱 (PMMA), PEEK, WAX, ABS 등 비철, 비금속 가공
- Endmills for PMMA, PEEK, WAX, A.B.S, non-ferrous and non-metallic materials.

단위 : mm

Order Number	날경 Diameter R x D	날장 Length of cut L1	유효장 Effective Length L2	전장 Overall Length L	생크 소경 Shank Dia d1	생크 Shank Dia d
2ARU 010 100 444	0.5R X 1	2	10	44	3	4
2ARU 015 140 447	0.75R X 1.5	3	14	47	3	4
2ARU 020 180 450	1R X 2	6	18	50	3	4

EARU 전착 다이아몬드 엔드밀 New

Electro Deposited Diamond End Mill

호환 장비 (Competible Machine)
5X300

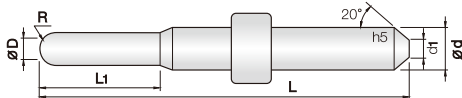

- 지르코니아 (ZrO₂), E-MAX, 얼티메이트 (Ultimate) 등 비철 비금속 가공 엔드밀
- 완전 소결된 지르코니아, 세라믹, 글라스 등의 가공에 적합합니다.
- 다이아몬드 입자를 니켈 도금하여 내마모 성능이 탁월합니다.
- 초경 모재를 사용하여 공구 휨이 적어 정밀가공에 적합합니다.
- Endmills for Zirconia, E-MAX, Ultimate, Non-ferrous and non-metallic materials.
- Milling process is suitable for completely sintered zirconia, ceramic and glass.
- Wear resistance is excellent by applying diamond particles with nickel plating
- Precision processing is available with less bending on the tool with carbide material

단위 : mm

Order Number	날경 Diameter R x D	날장 Length of cut L1	전장 Overall Length L	생크 소경 Shank Dia d1	생크 Shank Dia d
EARU 010 100 445	0.5R X 1	10	44.5	3	4
EARU 015 100 445	0.75R X 1.5	10	44.5	3	4
EARU 020 130 445	1R X 2	13	44.5	3	4
EARU 025 130 445	1.25R X 2.5	13	44.5	3	4

2&3ARUD

2&3날 지르코니아 가공용 다이아몬드 코팅 볼 엔드밀
2&3 Flutes Diamond Coated Ball End Mills for Zirconia

호환 장비(Competible Machine)
5X100, 5X150

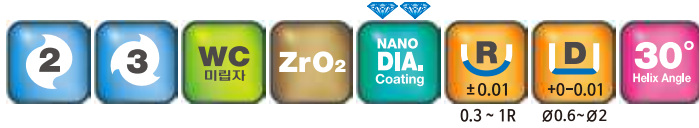
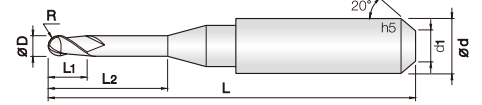

- 지르코니아(ZrO2), 얼티메이트(ULTIMATE) 등 비철 비금속 가공
- Endmills for Zirconia, Ultimate, non-ferrous and non-metallic materials.

단위 : mm

Order Number	날경 Diameter R × D	날장 Length of cut L1	유효장 Effective Length L2	전장 Overall Length L	샙크소경 Shank Dia d1	샙크 Shank Dia d	
2ARUD 006 130 063	0.3R X 0.6	2	13	63	4.2	6	
2ARUD 010 160 063	3ARUD 010 160 063	0.5R X 1	6	16	63	4.2	6
2ARUD 020 200 063	3ARUD 020 200 063	1R X 2	8	20	63	4.2	6

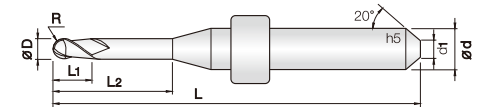

호환 장비(Competible Machine)
5X300

단위 : mm

Order Number	날경 Diameter R × D	날장 Length of cut L1	유효장 Effective Length L2	전장 Overall Length L	샙크소경 Shank Dia d1	샙크 Shank Dia d	
2ARUD 006 100 445	0.3R X 0.6	1.6	10	45	3	4	
2ARUD 010 160 450	3ARUD 010 160 450	0.5R X 1	2	16	50	3	4
2ARUD 020 180 450	3ARUD 020 180 450	1R X 2	6	18	50	3	4

2ARUT

2날 티타늄 / 코발트-크롬 가공용 리브 볼 엔드밀
2 Flutes Rib Ball End Mills for Titanium & Cobalt-Chrome

호환 장비(Competible Machine)
5X100, 5X150

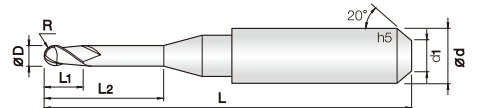

- 티타늄, 코발트-크롬 계열의 디스크 및 어버트먼트 정밀가공
- Endmills for titanium and cobalt-chrom disk & abutment

단위 : mm

Order Number	날경 Diameter R × D	날장 Length of cut L1	유효장 Effective Length L2	전장 Overall Length L	샙크소경 Shank Dia d1	샙크 Shank Dia d
2ARUT 010 080 S06	0.5R X 1	2	8	50	4.2	6
2ARUT 015 100 S06	0.75R X 1.5	3	10	50	4.2	6
2ARUT 020 120 S06	1R X 2	6	12	50	4.2	6
2ARUT 030 120 S06	1.5R X 3	8	12	50	4.2	6

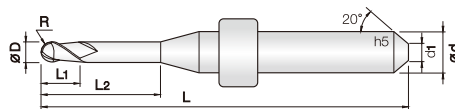

호환 장비(Competible Machine)
5X300

단위 : mm

Order Number	날경 Diameter R × D	날장 Length of cut L1	유효장 Effective Length L2	전장 Overall Length L	샙크소경 Shank Dia d1	샙크 Shank Dia d
2ARUT 015 100 443	0.75R X 1.5	4	10	43	3	4
2ARUT 020 120 444	1R X 2	6	12	44	3	4



1날 PMMA/PEEK/WAX 가공용 리브 볼 엔드밀 1 Flutes Rib Ball End Mills for PMMA & PEEK & WAX

호환 장비 (Competible Machine)
M1, M5

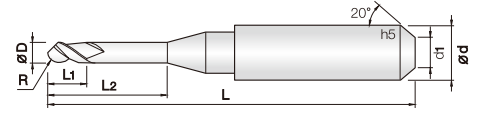

- 플라스틱 (PMMA), PEEK, WAX, ABS 등 비철, 비금속 가공
- Endmills for PMMA, PEEK, WAX, A.B.S, non-ferrous and non-metallic materials.

단위: mm

Order Number	날경 Diameter R × D	날장 Length of cut L1	유효장 Effective Length L2	전장 Overall Length L	샙크소경 Shank Dia d1	샙크 Shank Dia d
1ZIR 005 050 S03	0.25R X 0.5	3	5	57	1.2	3
1ZIR 005 050 S06	0.25R X 0.5	3	5	50	4.2	6
1ZIR 010 160 S03	0.5R X 1	8	16	57	1.2	3
1ZIR 010 120 S06	0.5R X 1	6	12	50	4.2	6
1ZIR 020 180 S03	1R X 2	10	18	57	1.2	3
1ZIR 020 180 S06	1R X 2	10	18	50	4.2	6



2&3날 지르코니아 가공용 리브 볼 엔드밀 2&3 Flutes Ball End Mills for Zirconia

호환 장비 (Competible Machine)
M1, M5

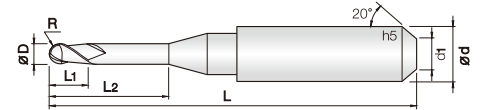

- 지르코니아 (ZrO2), 얼티메이트 (ULTIMATE) 등 비철 비금속 가공
- Endmills for Zirconia, Ultimate, non-ferrous and non-metallic materials.

단위: mm

Order Number	날경 Diameter R × D	날장 Length of cut L1	유효장 Effective Length L2	전장 Overall Length L	샙크소경 Shank Dia d1	샙크 Shank Dia d
2ZIR 005 050 S03	0.25R X 0.5	3	5	57	1.2	3
2ZIR 005 050 S06	0.25R X 0.5	3	5	50	4.2	6
2ZIR 010 160 S03	3ZIR 010 160 S03	0.5R X 1	8	16	1.2	3
2ZIR 010 120 S06	3ZIR 010 120 S06	0.5R X 1	6	12	4.2	6
2ZIR 020 180 S03	3ZIR 020 180 S03	1R X 2	10	18	1.2	3
2ZIR 020 180 S06	3ZIR 020 180 S06	1R X 2	10	18	4.2	6



2&3날 지르코니아 가공용 다이아몬드 코팅 볼 엔드밀 2&3 Flutes Diamond Coated Ball End Mills for Zirconia

호환 장비 (Competible Machine)
M1, M5

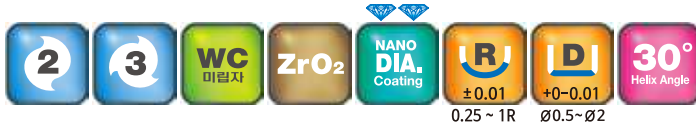
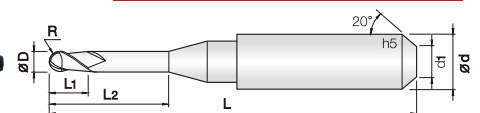
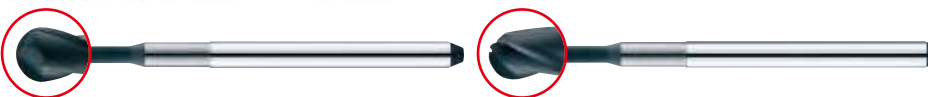

- 지르코니아 (ZrO2), 얼티메이트 (ULTIMATE) 등 비철 비금속 가공
- Endmills for Zirconia, Ultimate, non-ferrous and non-metallic materials.

단위: mm

Order Number	날경 Diameter R × D	날장 Length of cut L1	유효장 Effective Length L2	전장 Overall Length L	샙크소경 Shank Dia d1	샙크 Shank Dia d
2ZIRD 005 050 S03	0.25R X 0.5	3	5	57	1.2	3
2ZIRD 005 050 S06	0.25R X 0.5	3	5	50	4.2	6
2ZIRD 010 160 S03	3ZIRD 010 160 S03	0.5R X 1	8	16	1.2	3
2ZIRD 010 120 S06	3ZIRD 010 120 S06	0.5R X 1	6	12	4.2	6
2ZIRD 020 180 S03	3ZIRD 020 180 S03	1R X 2	10	18	1.2	3
2ZIRD 020 180 S06	3ZIRD 020 180 S06	1R X 2	10	18	4.2	6

2ZIIRT 2날 티타늄 / 코발트-크롬 가공용 리브 볼 엔드밀 2 Flutes Rib Ball End Mills for Titanium & Cobalt-Chrome

호환 장비 (Competible Machine)
M1

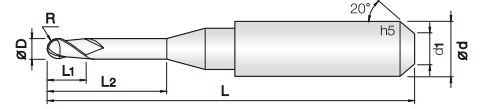

- 티타늄, 코발트-크롬 계열의 디스크 및 어버트먼트 정밀가공
- Endmills for titanium and cobalt-chrom disk & abutment

단위 : mm

Order Number	날경 Diameter R × D	날장 Length of cut L1	유효장 Effective Length L2	전장 Overall Length L	생크소경 Shank Dia d1	생크 Shank Dia d
2ZIIRT 020 180 S06	1R X 2	3	18	50	4.2	6
2ZIIRT 030 180 S06	1.5R X 3	4	18	50	4.2	6

1AMA 1날 PMMA/PEEK/WAX 가공용 리브 볼 엔드밀 1 Flutes Rib Ball End Mills for PMMA & PEEK & WAX

호환 장비 (Competible Machine)
Care Mill

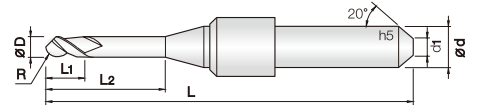

- 플라스틱 (PMMA), PEEK, WAX, ABS 등 비철, 비금속 가공
- Endmills for PMMA, PEEK, WAX, A.B.S, non-ferrous and non-metallic materials.

단위 : mm

Order Number	날경 Diameter R × D	날장 Length of cut L1	유효장 Effective Length L2	전장 Overall Length L	생크소경 Shank Dia d1	생크 Shank Dia d
1AMA 006 070 S03	0.3R X 0.6	2	7	47	1.6	3
1AMA 010 170 S03	0.5R X 1	6	17	47	1.6	3
1AMA 025 170 S03	1.25R X 2.5	9	17	47	1.6	3

2&3AMA 2&3날 지르코니아 가공용 다이아몬드 코팅 볼 엔드밀 2&3 Flutes Diamond Coated Ball End Mills for Zirconia

호환 장비 (Competible Machine)
Care Mill

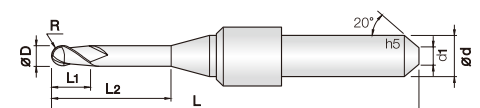
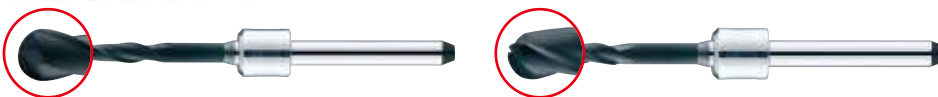

- 지르코니아 (ZrO2), 얼티메이트 (ULTIMATE) 등 비철 비금속 가공
- Endmills for Zirconia, Ultimate, non-ferrous and non-metallic materials.

단위 : mm

Order Number	날경 Diameter R × D	날장 Length of cut L1	유효장 Effective Length L2	전장 Overall Length L	생크소경 Shank Dia d1	생크 Shank Dia d
2AMA 003 140 S03	0.15R X 0.3	1.2	14 (2.5)	47	1.6	3
2AMA 006 070 S03	0.3R X 0.6	2	7	47	1.6	3
2AMA 006 120 S03	0.3R X 0.6	2	12	47	1.6	3
2AMA 010 170 S03	3AMA 010 170 S03	6	17	47	1.6	3
2AMA 025 170 S03	3AMA 025 170 S03	9	17	47	1.6	3